

## Pole-placement design

# Outline

- 1 Feedback design
  - The polynomial equation
  - Pre-chosen factors
  - Pole-placement versus IMC
- 2 Design trade-off
  - Avoid model matching formulation
  - Speed versus noise sensitivity
- 3 Example: Damping of a pendulum
  - Cascade feedback design
  - Reference feedforward design

# Outline

- 1 Feedback design
  - The polynomial equation
  - Pre-chosen factors
  - Pole-placement versus IMC
- 2 Design trade-off
  - Avoid model matching formulation
  - Speed versus noise sensitivity
- 3 Example: Damping of a pendulum
  - Cascade feedback design
  - Reference feedforward design

# Feedback can change stability properties

Process

$$Ay = Bu$$

Characteristic polynomial  $A$  determines stability

Feedback controller

$$Ru = -Sy$$

Closed-loop system

$$ARy = BRu = -BSy \rightarrow \underbrace{(AR + BS)}_{A_c} y = 0$$

Closed-loop characteristic polynomial  $A_c$  determines stability

# The pole-placement problem

Given process model polynomials  $A$  and  $B$

Given (chosen) closed-loop poles  $\lambda_1, \dots, \lambda_n$

$$\rightarrow A_c(q^{-1}) = (1 - \lambda_1 q^{-1}) \dots (1 - \lambda_n q^{-1}) = 1 + a_{c_1} q^{-1} + \dots + a_{c_n} q^{-n}$$

Calculate controller polynomials  $R$  and  $S$

$$AR + BS = A_c \quad \rightarrow \begin{cases} R \\ S \end{cases}$$

## Cancel common factors

Assume  $A$  and  $B$  coprime (no common factors)

Study common factors between  $A_c$  and  $A$  or  $B$

$$(A_1 A_2)R + (B_1 B_2)S = A_{c1} A_{c2}$$

Same factors must be on left and right hand side:

## Cancel common factors

Assume  $A$  and  $B$  coprime (no common factors)

Study common factors between  $A_c$  and  $A$  or  $B$

$$(A_1A_2)R + (B_1B_2)S = A_{c1}A_{c2}$$

Same factors must be on left and right hand side:

- $A_{c2} = A_2 \Rightarrow S = S_1A_2$ . Cancel common factor  $A_2$

$$A_1R + BS_1 = A_{c1} \rightarrow \begin{cases} R \\ S_1 \end{cases}$$

## Cancel common factors

Assume  $A$  and  $B$  coprime (no common factors)

Study common factors between  $A_c$  and  $A$  or  $B$

$$(A_1A_2)R + (B_1B_2)S = A_{c1}A_{c2}$$

Same factors must be on left and right hand side:

- $A_{c2} = A_2 \Rightarrow S = S_1A_2$ . Cancel common factor  $A_2$

$$A_1R + BS_1 = A_{c1} \rightarrow \begin{cases} R \\ S_1 \end{cases}$$

- $A_{c2} = B_2 \Rightarrow R = R_1B_2$

$$AR_1 + B_1S = A_{c1} \rightarrow \begin{cases} R_1 \\ S \end{cases}$$



# An equivalent equation system

Assume  $A$ ,  $B$  and  $A_c$  coprime

Identify coefficient of  $q^{-k}$ :

$$\sum_{i+j=k} a_i r_j + \sum_{i+j=k} b_i s_j = a_{c_k}, \quad k = 0, \dots, n$$

In matrix form

$$n+1 \left\{ \underbrace{\begin{pmatrix} a_0 & \dots & 0 & b_0 & \dots & 0 \\ a_1 & \ddots & \vdots & b_1 & \ddots & \vdots \\ a_2 & \ddots & a_0 & b_2 & \ddots & b_0 \\ \vdots & \ddots & \vdots & \vdots & \ddots & \vdots \end{pmatrix}}_{\text{deg } R+1} \underbrace{\begin{pmatrix} r_0 \\ \vdots \\ s_0 \\ \vdots \end{pmatrix}}_{\text{deg } S+1} = \begin{pmatrix} a_{c_0} \\ a_{c_1} \\ \vdots \\ a_{c_n} \end{pmatrix}$$

Unique solution if  $n+1 = \text{deg } R + \text{deg } S + 2$

# Degree conditions for unique solution

To solve

$$AR + BS = A_c \rightarrow \begin{cases} R \\ S \end{cases}$$

choose

$$\begin{cases} \deg A_c \leq \deg A + \deg B - 1 \\ \deg R = \deg B - 1 \\ \deg S = \deg A - 1 \end{cases}$$

# Example

Process model

$$\frac{B}{A} = \frac{b_1q^{-1} + b_2q^{-2}}{1 + a_1q^{-1} + a_2q^{-2}}$$

Degree conditions give

$$\deg A_c \leq \deg AB - 1 = 3, \quad A_c = 1 + a_{c1}q^{-1} + a_{c2}q^{-2} + a_{c3}q^{-3}$$

$$\deg R = \deg B - 1 = 1, \quad R = r_0 + r_1q^{-1}$$

$$\deg S = \deg A - 1 = 1, \quad S = s_0 + s_1q^{-1}$$

$$\begin{pmatrix} 1 & 0 & 0 & 0 \\ a_1 & 1 & b_1 & 0 \\ a_2 & a_1 & b_2 & b_1 \\ 0 & a_2 & 0 & b_2 \end{pmatrix} \begin{pmatrix} r_0 \\ r_1 \\ s_0 \\ s_1 \end{pmatrix} = \begin{pmatrix} 1 \\ a_{c1} \\ a_{c2} \\ a_{c3} \end{pmatrix} \rightarrow \begin{pmatrix} r_0 \\ r_1 \\ s_0 \\ s_2 \end{pmatrix}$$

## Example: simplifications

Use that  $r_0 = 1$  and eliminate first row and column

$$\begin{pmatrix} 1 & b_1 & 0 \\ a_1 & b_2 & b_1 \\ a_2 & 0 & b_2 \end{pmatrix} \begin{pmatrix} r_1 \\ s_0 \\ s_1 \end{pmatrix} = \begin{pmatrix} a_{c1} - a_1 \\ a_{c1} - a_2 \\ a_{c3} \end{pmatrix} \rightarrow \begin{pmatrix} r_1 \\ s_0 \\ s_2 \end{pmatrix}$$

Alternatively:

Evaluate at roots  $A(p_1) = A(p_2) = B(z_1) = 0$

$$\left. \begin{aligned} B(p_1)S(p_1) &= A_c(p_1) \\ B(p_2)S(p_2) &= A_c(p_2) \end{aligned} \right\} \rightarrow \begin{pmatrix} s_0 \\ s_1 \end{pmatrix}$$

$$A(z_1)R(z_1) = A_c(z_1) \rightarrow r_1$$

# Outline

- 1 Feedback design
  - The polynomial equation
  - Pre-chosen factors
  - Pole-placement versus IMC
- 2 Design trade-off
  - Avoid model matching formulation
  - Speed versus noise sensitivity
- 3 Example: Damping of a pendulum
  - Cascade feedback design
  - Reference feedforward design

# Pre-chosen fixed factors in R and S

Closed-loop disturbance response  $d \rightarrow y$

$$y = \frac{RC}{A_c} d$$

Constant (low frequency) disturbance eliminated if  $R(1) = 0$

Closed-loop disturbance response  $d \rightarrow u$

$$u = -\frac{SC}{A_c} d$$

Noise (high frequency) disturbance eliminated if  $S(-1) = 0$

# Pre-chosen fixed factors in $R$ and $S$

Closed-loop disturbance response  $d \rightarrow y$

$$y = \frac{RC}{A_c} d$$

Constant (low frequency) disturbance eliminated if  $R(1) = 0$

Closed-loop disturbance response  $d \rightarrow u$

$$u = -\frac{SC}{A_c} d$$

Noise (high frequency) disturbance eliminated if  $S(-1) = 0$

Pre-chosen factors  $R_f$  and  $S_f$

Find solution  $AR + BS = A_c$  such that  $R = R_1 R_f$  and  $S = S_1 S_f$

## Polynomial equation with fixed factors

Associate fixed factors to process  $A' = AR_f$ ,  $B' = BS_f$

$$A'R_1 + B'S_1 = A_c, \rightarrow \begin{cases} R_1 \\ S_1 \end{cases}$$

with degree conditions

$$\deg A_c \leq \deg A'B' - 1$$

$$\deg R_1 = \deg B' - 1$$

$$\deg S_1 = \deg A' - 1$$

Associate fixed factors back to controller

$$\begin{cases} R = R_1 R_f \\ S = S_1 S_f \end{cases}$$



## Example: Ignition control of a car engine

For an optimal performance the pressure peak position (PPP) should be kept constant at a given crank angle.

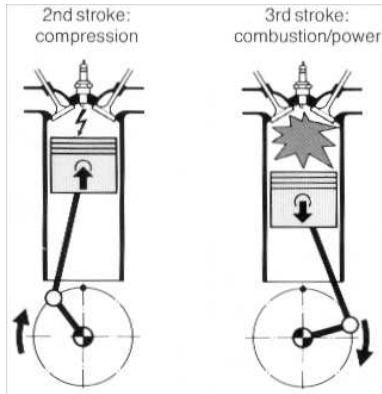

# Example: ignition control...

Model

$$y(k) = b_1 u(k-1) + d \quad \left\{ \begin{array}{l} k \text{ combustion cycle} \\ y \text{ } PPP \\ u \text{ ignition crank angle} \\ d \text{ low frequency disturbance} \end{array} \right.$$

Controller design with integral action  $R_f = 1 - q^{-1}$

Model  $A = 1$ ,  $B = b_1 q^{-1}$  and  $A' = AR_f$

$$\deg A_c \leq \deg A' + \deg B - 1 = 1, \quad A_c = 1 - \lambda q^{-1}$$

$$\deg R_1 = \deg B - 1 = 0,$$

$$R_1 = 1, \quad R = R_f = 1 - q^{-1}$$

$$\deg S = \deg A' - 1 = 0,$$

$$S = s_0$$

## Example: ignition control...

Polynomial equation

$$A'R_1 + BS = (1 - q^{-1}) + b_1 q^{-1} s_0 = 1 - (1 - b_1 s_0) q^{-1} = A_c = 1 - \lambda q^{-1}$$

Design by choosing closed-loop pole  $\lambda$

$$s_0 = (1 - \lambda) / b_1$$

Choose  $T$  for steady-state gain 1

$$\frac{BT}{A_c}(1) = 1 \rightarrow T = \frac{A_c}{B}(1) = \frac{A(1)R(1) + B(1)S(1)}{B(1)} = S(1) = s_0$$

Integral controller ( $Ru = -Sy + Tr = s_0 e$ )

$$u = \frac{s_0}{1 - q^{-1}} e$$

# Example: experimental results

PPP Pressure peak position,  $y$  and setpoint (red)

IGN Ignition before top dead center,  $-u$

MAP Manifold air pressure, (low frequency) disturbance  $d$

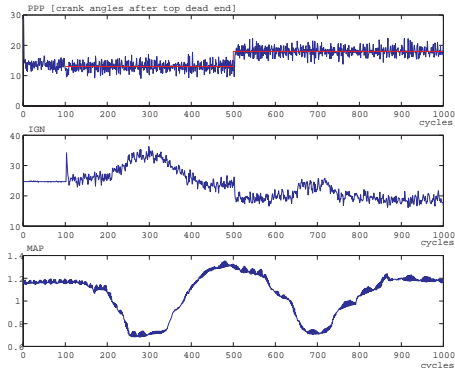

## Example: ignition control—why not PI?

PI-control structure

$$\frac{S}{R} = \frac{s_0 + s_1 q^{-1}}{1 - q^{-1}}$$

Closed-loop characteristic polynomial

$$AR + BS = (1 - q^{-1}) + b_1 q^{-1} (s_0 + s_1 q^{-1}) = 1 + (b_1 s_0 - 1) q^{-1} + b_1 s_1 q^{-2}$$

Compare with

$$A_c = (1 - \lambda_1 q^{-1})(1 - \lambda_2 q^{-1}) = 1 - (\lambda_1 + \lambda_2) q^{-1} + \lambda_1 \lambda_2 q^{-2}$$

With backward-difference approximation  $s_1 = -K$

$$\lambda_1 \lambda_2 = b_1 s_1 = -b_1 K < 0 \Rightarrow \lambda_1 > 0, \quad \lambda_2 < 0$$

## Example: ignition control—why not PI?

PI-control structure

$$\frac{S}{R} = \frac{s_0 + s_1 q^{-1}}{1 - q^{-1}}$$

Closed-loop characteristic polynomial

$$AR + BS = (1 - q^{-1}) + b_1 q^{-1} (s_0 + s_1 q^{-1}) = 1 + (b_1 s_0 - 1) q^{-1} + b_1 s_1 q^{-2}$$

Compare with

$$A_c = (1 - \lambda_1 q^{-1})(1 - \lambda_2 q^{-1}) = 1 - (\lambda_1 + \lambda_2) q^{-1} + \lambda_1 \lambda_2 q^{-2}$$

With backward-difference approximation  $s_1 = -K$

$$\lambda_1 \lambda_2 = b_1 s_1 = -b_1 K < 0 \Rightarrow \lambda_1 > 0, \quad \lambda_2 < 0$$

Why not PI for this problem?

One nasty oscillating pole on negative real axis!

# Example: Plate and fan

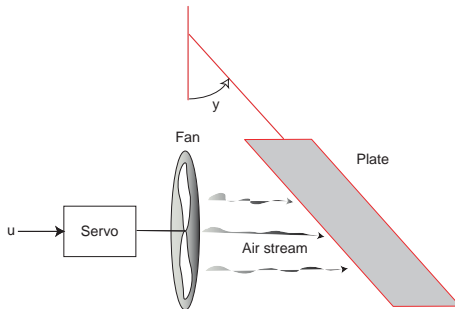

# Plate and fan: PID design (Ziegler-Nichols)

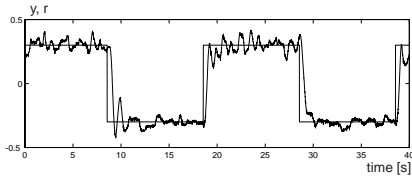

PID (sampling  $h = 0.01s$ )

*Estimate:* steady-state gain

$$\frac{\Delta y}{\Delta u} \approx \frac{0.6}{0.8} = b_1$$

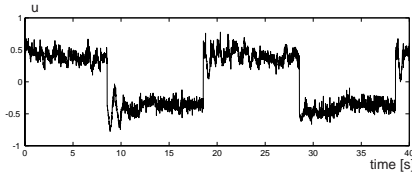



# Plate and fan: Discrete-time design—tuned slow

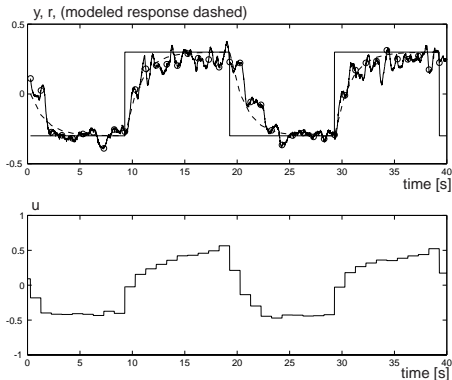

Discrete model ( $h = 1s$ )

$$y(k) = b_1 u(k-1)$$

I-controller

$$u(k) = \frac{s_0}{1 - q^{-1}} e(k)$$

gives closed-loop response

$$y(k) = \frac{(1 - \lambda)q^{-1}}{1 - \lambda q^{-1}} r(k)$$

Design  $\lambda = 1 - b_1 s_0 = 0.5$

# Plate and fan: Discrete-time design—tuned faster

Faster design  $\lambda = 0.25$

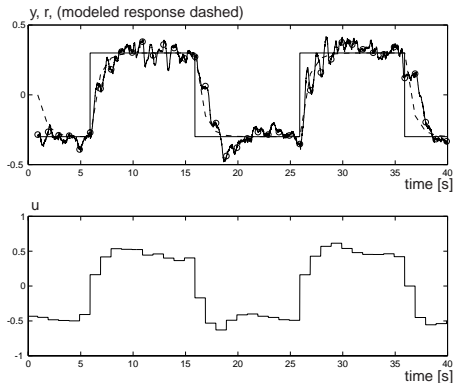

# Plate and fan: Discrete-time design—tuned fastest

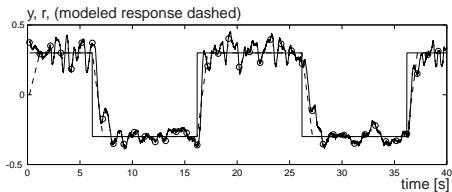

Fastest design (dead-beat)  
 $\lambda = 0 \Rightarrow y(k) = r(k - 1)$

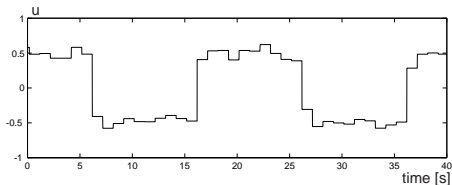

# Plate and fan: Discrete-time design—tuned fastest

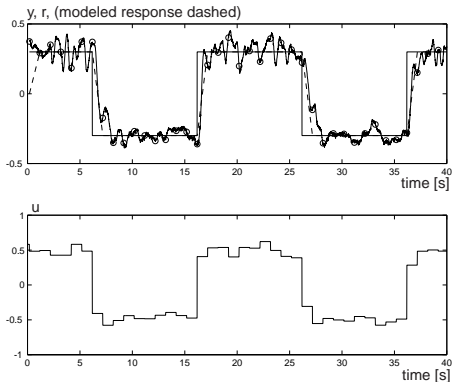

Fastest design (dead-beat)

$$\lambda = 0 \Rightarrow y(k) = r(k - 1)$$

Discrete design compared to  
discretized continuous design

Same performance but with  
100 times slower sampling

## Example: Magnetic suspension system

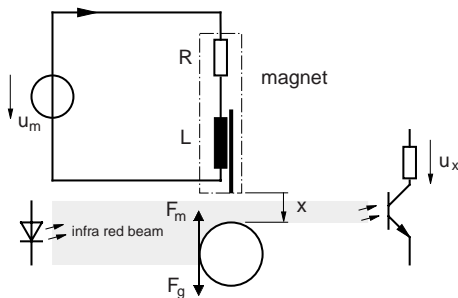

Dynamics of suspending ball

$$m\ddot{x} = F_g - F_m \quad \begin{cases} F_g = mg & \text{gravitational force} \\ F_m = -\frac{1}{2} \frac{dL}{dx} i^2 & \text{magnetic force} \end{cases}$$

# Example: Magnetic suspension system—PD-control

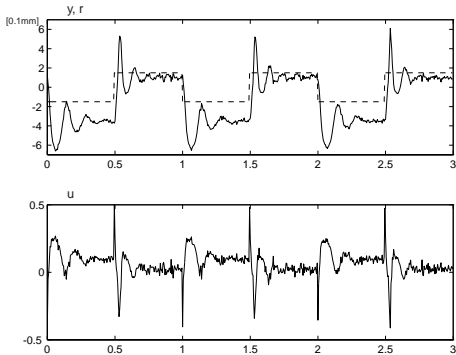

# Example: Magnetic suspension system—Discrete design

Linearized dynamics

$$G(s) = \frac{b}{s^2 - a}$$

Zero-order-hold sampling

$$\frac{B(q^{-1})}{A(q^{-1})} = \gamma \frac{q^{-1} + q^{-2}}{1 - \beta q^{-1} + q^{-2}}, \quad \beta > 0$$

Controller design with integral action  $R_f = 1 - q^{-1}$

Controller structure

$$\begin{aligned} \deg A_c &\leq \deg A'B - 1 = 4, & A_c &= (1 - \lambda_1 q^{-1}) \dots (1 - \lambda_4 q^{-1}) \\ \deg R_1 &= \deg B - 1 = 1, & R &= R_1 R_f = (1 + r_1 q^{-1})(1 - q^{-1}) \\ \deg S &= \deg A' - 1 = 2, & S &= s_0 + s_1 q^{-1} + s_2 q^{-2} \end{aligned}$$

Pole placement  $\lambda_k = 0.95, 0.54, 0.33, 0.21, k = 1, \dots, 4$

# Example: Magnetic suspension system—Discrete design

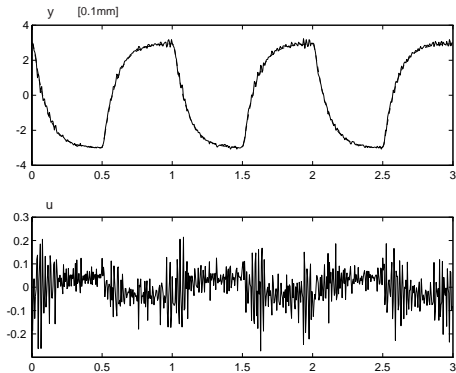



# Example: Magnetic suspension system—Discrete design

Reduce noise feedback by choosing  $S_f = 1 + q^{-1}$  ( $S_f(-1) = 0$ )

Keep integral action  $R_f = 1 - q^{-1}$

Controller structure

$$\deg A_c \leq \deg A'B' - 1 = 5, \quad A_c = (1 - \lambda_1 q^{-1}) \dots (1 - \lambda_5 q^{-1})$$

$$\deg R_1 = \deg B' - 1 = 2, \quad R_1 = 1 + r_1 q^{-1} + r_2 q^{-2}$$

$$\deg S_1 = \deg A' - 1 = 2, \quad S_1 = s_0 + s_1 q^{-1} + s_2 q^{-2}$$

Higher complexity:  $R = R_1 R_f$ ,  $S = S_1 S_f$  both of degree 3

# Example: Discrete design with reduced noise feedback

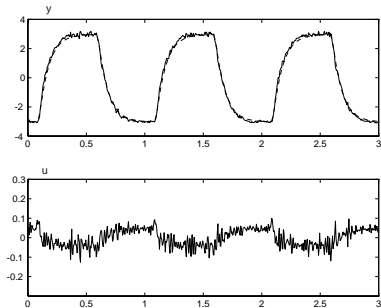

Compare trade-off between tracking and control effort

$S_f$	$std(e_u)$ [ $\mu$ ]	$\max  \Delta u $
1	10	0.45
$1 + q^{-1}$	15	0.12

# Outline

- 1 Feedback design
  - The polynomial equation
  - Pre-chosen factors
  - Pole-placement versus IMC
- 2 Design trade-off
  - Avoid model matching formulation
  - Speed versus noise sensitivity
- 3 Example: Damping of a pendulum
  - Cascade feedback design
  - Reference feedforward design

# IMC design

Process with input-disturbance and badly damped poles

$$y(k) = \frac{q^{-1}}{(1 - \lambda_1 q^{-1})(1 - \lambda_2 q^{-1})} [u(k) + d(k)], \quad \lambda_{1,2} = 0.1 \pm i0.99$$

IMC design

$$\begin{aligned} A_c &= ABq = A \\ R &= Bq(1 - q^{-1}) = (1 - q^{-1}) \\ S &= T = A \end{aligned}$$

Closed-loop response

$$y = \frac{BT}{A_c} r + \frac{BR}{A_c} d = q^{-1} r + \frac{q^{-1}(1 - q^{-1})}{A} d$$

# Pole-placement design

Polynomial equation

$$AR + BS = A_c$$

Integral action  $R_f = 1 - q^{-1}$  ( $A' = AR_f$ ,  $R = R_1 R_f$ )

$$\deg A_c = \deg A'B - 1 = 3$$

$$\deg R_1 = \deg B - 1 = 0, \quad R = R_1 R_f = 1 - q^{-1}$$

$$\deg S = \deg A' - 1 = 2$$

Same reference response as IMC if  $T = A_c$

$$y = \frac{BT}{A_c} r + \frac{BR}{A_c} d = q^{-1} r + \frac{q^{-1}(1 - q^{-1})}{A_c} d$$

# Pole-placement design versus IMC

Reference  $r$  (dashed) and step disturbance  $d$  at 20

IMC response

$$y = q^{-1}r + \frac{(1 - q^{-1})}{A}d$$

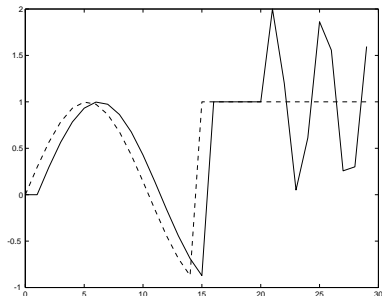

Pole-placement  $A_c = 1$

$$y = q^{-1}r + q^{-1}(1 - q^{-1})d$$

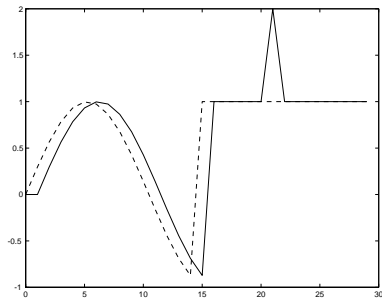

# Outline

- 1 Feedback design
  - The polynomial equation
  - Pre-chosen factors
  - Pole-placement versus IMC
- 2 Design trade-off
  - Avoid model matching formulation
  - Speed versus noise sensitivity
- 3 Example: Damping of a pendulum
  - Cascade feedback design
  - Reference feedforward design

# Model matching

Sometimes pole placement design is presented as *model matching*:  
Given desired reference model

$$y = Hr, \quad H = \frac{B_H}{A_H}$$

Matching to closed-loop reference response

$$\frac{B_H}{A_H} = \frac{BT}{A_c} \Rightarrow \begin{cases} T = B_H A_o \\ A_c = A_H A_o B \end{cases}$$

Pole placement:  $A_H A_o$  chosen freely **but not  $B$**   
Misleading design approach!

**Better to choose  $A_c$  than  $B_H$**



## Example

A DC motor with transfer function

$$G(s) = \frac{4}{s(s+2)}$$

is sampled ( $h = 0.025s$ ) to discrete-time model

$$\frac{B}{A} = \frac{1.23 \cdot 10^{-3} q^{-1} (1 + 0.98q^{-1})}{(1 - q^{-1})(1 - 0.95q^{-1})}$$

Study three design choices:

- Choose reference model  $H = \frac{0.2q^{-1}}{1-0.8q^{-1}}$
- Choose pole placement  $A_c = 1 - 0.8q^{-1}$
- Choose pole placement at 0.95, 0.93 and 0.9

## Example: problem a)

Pole placement includes factor  $B_2 = 1 + 0.98q^{-1}$

$$A_c = (1 - 0.8q^{-1})(1 + 0.98q^{-1}) \Rightarrow R = R_1 B_2$$

Cancel common factor  $B_2$

$$AR_1 + B_1 S = A_{c1} \quad \left\{ \begin{array}{l} \deg R_1 = \deg B_1 - 1 = 0, \\ \deg S = \deg A - 1 = 1, \end{array} \right. \quad \begin{array}{l} R = R_1 B_2 = B_2 \\ S = s_0 + s_1 q^{-1} \end{array}$$

Evaluate at poles ( $A(1) = A(0.95^{-1}) = 0$ )

$$\left. \begin{array}{l} B(1)S(1) = A_c(1) \\ B(0.95^{-1})S(0.95^{-1}) = A_c(0.95^{-1}) \end{array} \right\} \Rightarrow S = 935 - 772q^{-1}$$

Adjust steady-state gain  $T = A_c(1)/B(1) = 163$

# Example: a)

Response without and with measurement noise

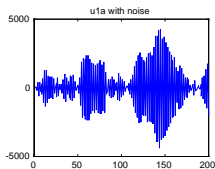
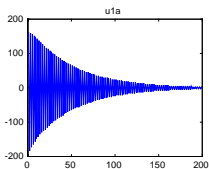
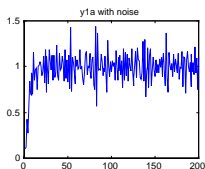
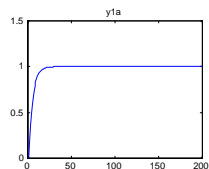

$$A_c = (1 - 0.8q^{-1}) \underbrace{(1 + 0.98q^{-1})}_{B_2}$$

$$y = \frac{BT}{A_c} r + \frac{RA}{A_c} d$$

$$u = \frac{AT}{A_c} r - \frac{SA}{A_c} d$$

Pole at  $-0.98$  not canceled in control signal response  
→ Rippling of control signal

## Example: b)

Response without and with measurement noise

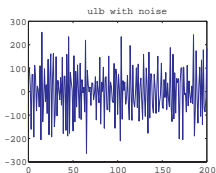
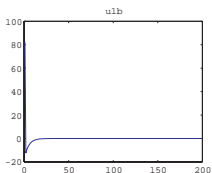
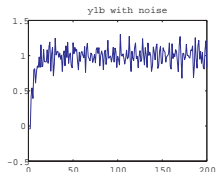
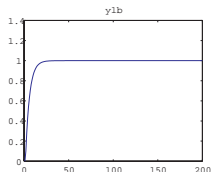

$$A_c = 1 - 0.8q^{-1}$$

$$y = \frac{BT}{A_c} r + \frac{RA}{A_c} d$$
$$u = \frac{AT}{A_c} r - \frac{SA}{A_c} d$$

Well damped pole at 0.8

→ No rippling of control signal

## Example: c)

Response without and with measurement noise

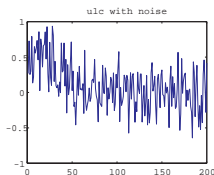
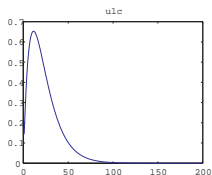
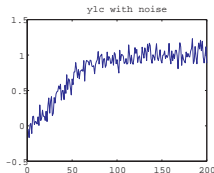
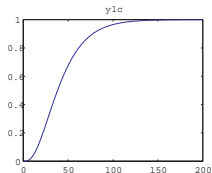

$$A_c(\lambda^{-1}) = 0,$$

$$\lambda = 0.95, 0.93, 0.9$$

$$y = \frac{BT}{A_c} r + \frac{RA}{A_c} d$$

$$u = \frac{AT}{A_c} r - \frac{SA}{A_c} d$$

$$\text{Noise gain } \left| \frac{SA}{A_c}(-1) \right| \approx 3$$

Compare **a)**  $2 \cdot 10^5$ , **b)** 2000

# Outline

- 1 Feedback design
  - The polynomial equation
  - Pre-chosen factors
  - Pole-placement versus IMC
- 2 Design trade-off
  - Avoid model matching formulation
  - Speed versus noise sensitivity
- 3 Example: Damping of a pendulum
  - Cascade feedback design
  - Reference feedforward design

# Servo control designs

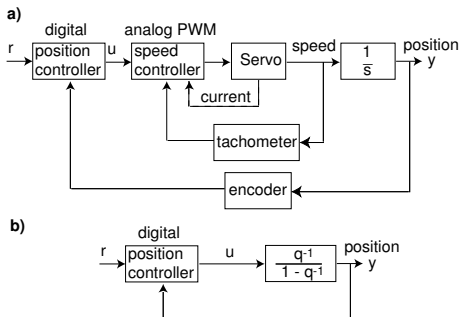

Discrete model

$$y(k) = y(k - 1) + u(k - 1), \quad A = 1 - q^{-1}, B = q^{-1}$$

Study designs with integral action  $R_f = 1 - q^{-1}$

# R and S

Degree conditions ( $A' = AR_f$ )

$$\begin{aligned}\deg A_c &= \deg A'B - 1 = 2, & A_c &= (1 - \lambda_1 q^{-1})(1 - \lambda_2 q^{-1}) \\ \deg R_1 &= \deg B - 1 = 0, & R &= R_1 R_f = (1 - q^{-1}) \\ \deg S &= \deg A' - 1 = 1, & S &= s_0 + s_1 q^{-1}\end{aligned}$$

Since  $R$  known,  $S$  is solved directly as

$$\begin{aligned}A_c &= 1 + a_{c1} q^{-1} + a_{c2} q^{-2} \\ AR &= (1 - q^{-1})^2 = 1 - 2q^{-1} + q^{-2} \\ S &= B^{-1}(A_c - AR) = (a_{c1} + 2) + (a_{c2} - 1)q^{-1}\end{aligned}$$

Since  $a_{c1} = -\lambda_1 - \lambda_2$  and  $a_{c2} = \lambda_1 \lambda_2$

$$\begin{aligned}s_0 &= 2 - \lambda_1 - \lambda_2 \\ s_1 &= \lambda_1 \lambda_2 - 1\end{aligned}$$



# T=S (PI structure)

Choosing PI structure  $T = S$ :

$$u = \frac{S}{R}e = \frac{s_0 + s_1q^{-1}}{1 - q^{-1}}e$$

Reference response with zero at  $z_1 = -s_1/s_0$

$$y = \frac{BS}{A_c}r = \frac{s_0 + s_1q^{-1}}{(1 - \lambda_1q^{-1})(1 - \lambda_2q^{-1})}q^{-1}r$$

Pole-placement design

$$\left. \begin{array}{l} \lambda_1 = 0.7 \\ \lambda_2 = 0.8 \end{array} \right\} \Rightarrow z_1 = 0.88$$

The zero causes overshoot!

# PI structure

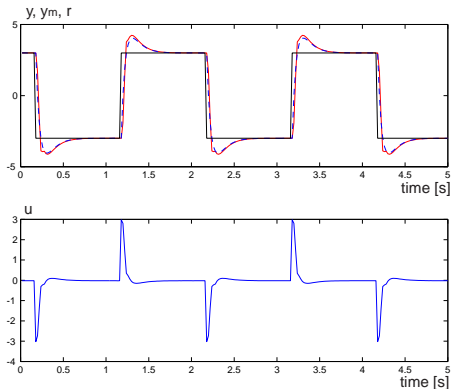

The zero causes **overshoot!**

## T scalar

Choose instead  $T = S(1) = s_0 + s_1$  scalar  $\rightarrow$  no zero introduced!

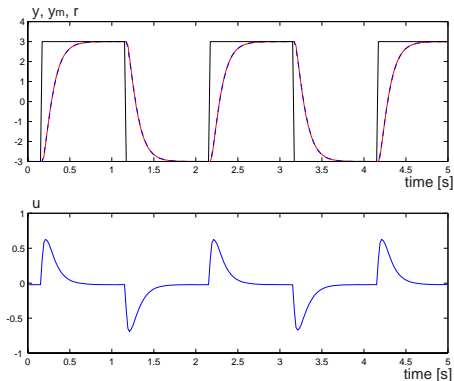

No overshoot, but slow!

# Faster response

Faster response with pole placement  $\lambda_1 = 0.7$ ,  $\lambda_2 = 0$

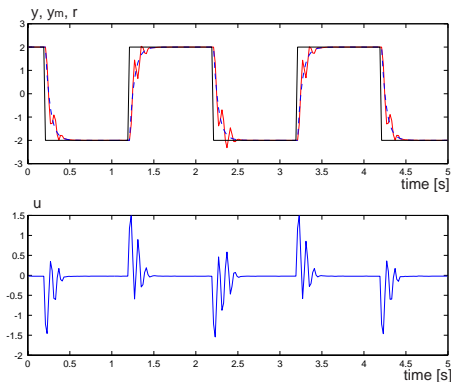

But, unmodeled dynamics excited!

## Faster response with less noise feedback

Measurement noise feedback to control signal

$$u = -\frac{AS}{A_c}d$$

Make this more low pass by the slow pole  $\lambda_2 = 0.8$

$$A_c = (1 - 0.7q^{-1})(1 - 0.8q^{-1})$$

Fast response by canceling the slow pole

$$T = (1 - 0.8q^{-1})S(1)/0.2$$

Steady-state gain is one:  $T(1) = A_c(1)/B(1) = S(1)$

# Faster response with less noise feedback

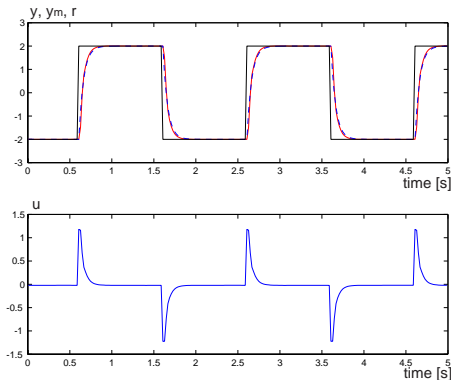

# Outline

- 1 Feedback design
  - The polynomial equation
  - Pre-chosen factors
  - Pole-placement versus IMC
- 2 Design trade-off
  - Avoid model matching formulation
  - Speed versus noise sensitivity
- 3 Example: Damping of a pendulum
  - Cascade feedback design
  - Reference feedforward design

# Damping of a pendulum

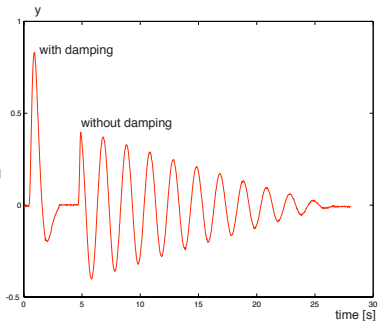
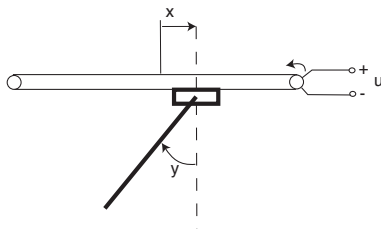



# Cascade control

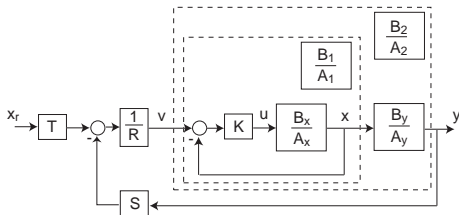

Trailer dynamics  $A_x x = B_x u$

P controller  $u = Ke$ ,  $e = v - x$

Closed loop  $A_1 x = B_1 v$

$$\begin{cases} A_1 = A_x + KB_x \\ B_1 = KB_x \end{cases}$$

Pendulum dynamics  $A_y y = B_y x$

Outer loop model

$$\begin{cases} A_2 = A_1 A_y \\ B_2 = B_1 B_y \end{cases} \begin{cases} A_1 \text{ well damped} \\ A_y \text{ badly damped} \end{cases}$$

# Trailer control

Step response for inner loop (**modeled** and **measured** response)

$$x = \frac{B_1}{A_1} v$$

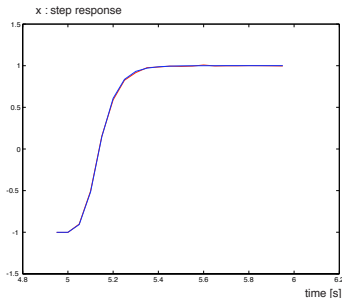

# Pendulum model

Pendulum dynamics  $A_y y = B_y x$

$$\begin{cases} A_y = (1 - \lambda q^{-1})(1 - \lambda^* q^{-1}) \\ B_y = b_0(1 - q^{-1})^2 \end{cases}$$

complex poles  $\lambda, \lambda^* = \text{conj}[\lambda]$  close to unit circle

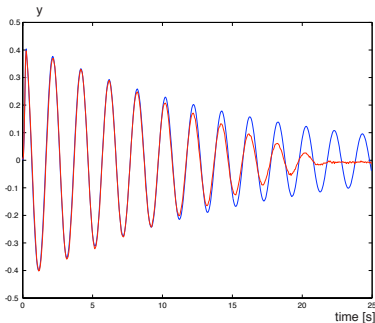

## Outer loop feedback design

Keep  $A_1$  (well damped) in pole placement

$$\begin{cases} A_c = A_1 A_{c1} \\ S = A_1 S_1 \end{cases}$$

Polynomial equation (cancel common factor  $A_1$ )

$$A_y R + S_1 B_2 = A_{c1}$$

$$\begin{cases} \deg A_{c1} \leq \deg A_y + \deg B_2 - 1 = 6 \\ \deg R = \deg B_2 - 1 = 4 \\ \deg S_1 = \deg A_y - 1 = 1 \end{cases}$$

Chosen well damped poles

$$A_{c1} = \prod_{k=1}^6 (1 - \lambda_k q^{-1})$$
$$\lambda_k = 0.85, 0.8, 0.75, 0.7, 0.65, 0.6$$

# Outline

- 1 Feedback design
  - The polynomial equation
  - Pre-chosen factors
  - Pole-placement versus IMC
- 2 Design trade-off
  - Avoid model matching formulation
  - Speed versus noise sensitivity
- 3 Example: Damping of a pendulum
  - Cascade feedback design
  - Reference feedforward design

# Reference to trailer position

Reference to trailer position  $x$

$$v(\infty) = \frac{A_2 T}{A_c}(1)r(\infty), \quad \rightarrow T = \frac{A_c}{A_2}(1) = R(1)$$

